

SPEC SHEET

PRODUCT DESCRIPTION

- Logan 72 Double wall mount cabinet
- Available in Natural Elm (36), Matte White (50), Rock Gray (52) and Natural Walnut (56) finish
- Cabinet is fully assembled
- Hardwood Plywood box construction
- Soft close doors and drawer
- Features 4 glass dividers on the top drawer
- Features a removable wood divider on the bottom drawer
- Blum wall hung system
- Solid Surface counter top with integrated basins and infinity drains in Matt White
- Solid Surface material is 38% polyester resin and 40% aluminum hydroxide powder
- Drain assembly and 10" drain tail included
- Basin depth is 3 1/2"

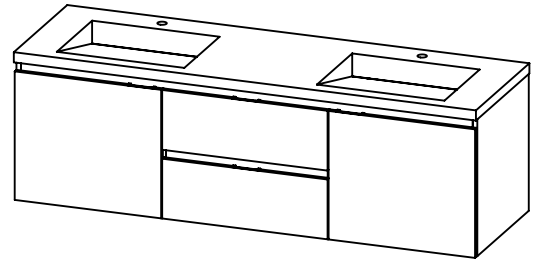

ROUGHING-IN DIMENSIONS

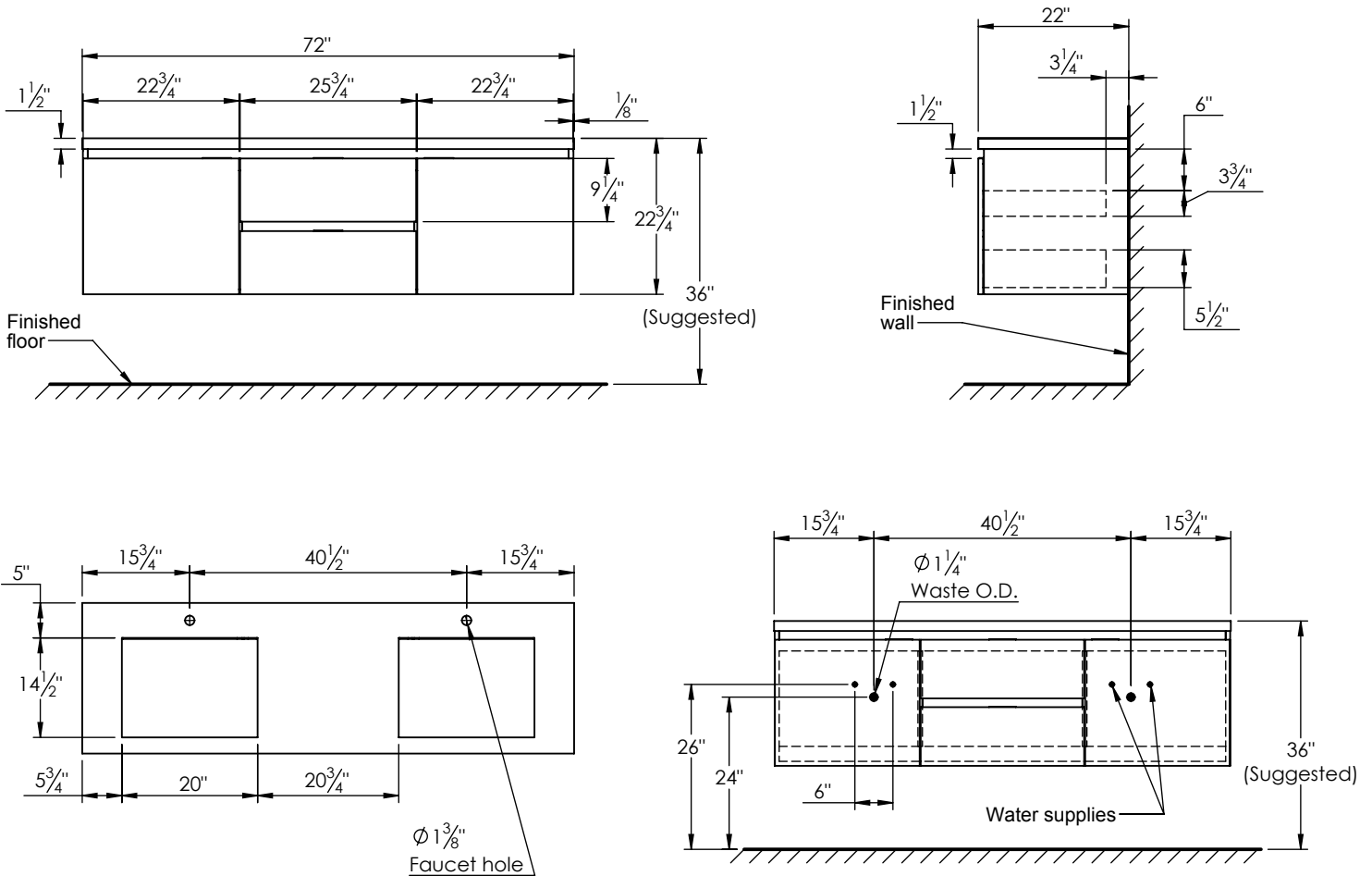

ROUGH PLUMBING